

Fixed and Functional



POWER
SCOPE™ 2

Self-Ligating
BracketsMetal
BracketsCeramic
BracketsDB
Tubes

Bands

Lingual
AttachmentsWeldable
Tubes

Adhesives

Wire

Elastomers

Mini
ImplantsFixed &
FunctionalStops
& Hooks

Extraoral

Instruments

Supplies
& Marketing

Custom Rx



PowerScope™ 2

- One-size-fits-all Class II corrector for simple treatment application and easy inventory management
- Internal NiTi spring mechanism delivers 260 grams of force for continuous activation during treatment
- Connects wire-to-wire for quick and easy chairside installation
- Can be used with both bondable or banded molar tubes
- No molar headgear tube or special band required
- Telescoping mechanism assemblies will not disengage during treatment
- Dental correction only

PowerScope 2

| 1 Patient Kit 852-016537 | | | | 5 Patient Kit 852-016538 | | | | |
|-----------------------------|--------------|------|-----|-----------------------------|----------------------|---|---|--|
| Qty | Right | Left | Qty | Right | Left | | | |
| 2 | PowerScope 2 | 1 | 1 | 10 | PowerScope 2 | 5 | 5 | |
| | | | | 1 | Hex head driver | | | |
| | | | | 5 | Driver magnets | | | |
| | | | | 10 | 1 mm Crimpable shims | | | |
| | | | | 10 | 2 mm Crimpable shims | | | |
| | | | | 10 | 3 mm Crimpable shims | | | |

PowerScope 2 Accessories

| | |
|------------|------------------------------------|
| 852-016539 | PowerScope 2 right arm |
| 852-016540 | PowerScope 2 left arm |
| 852-016541 | Replacement attachment nuts |
| 855-733 | 1 mm crimpable shims, 10/pkg |
| 855-728 | 2 mm crimpable shims, 10/pkg |
| 855-738 | 3 mm crimpable shims, 10/pkg |
| 855-515 | Hex head driver |
| 852-026533 | PowerScope 2 driver magnets, 5/pkg |

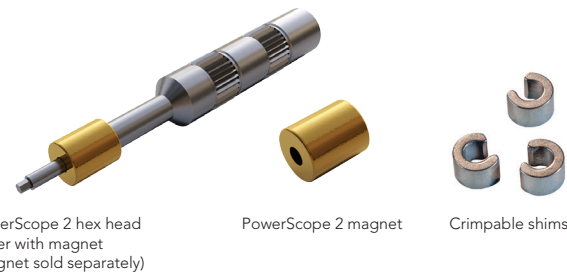

PowerScope 2 hex head driver with magnet (magnet sold separately)

PowerScope 2 magnet

Crimpable shims

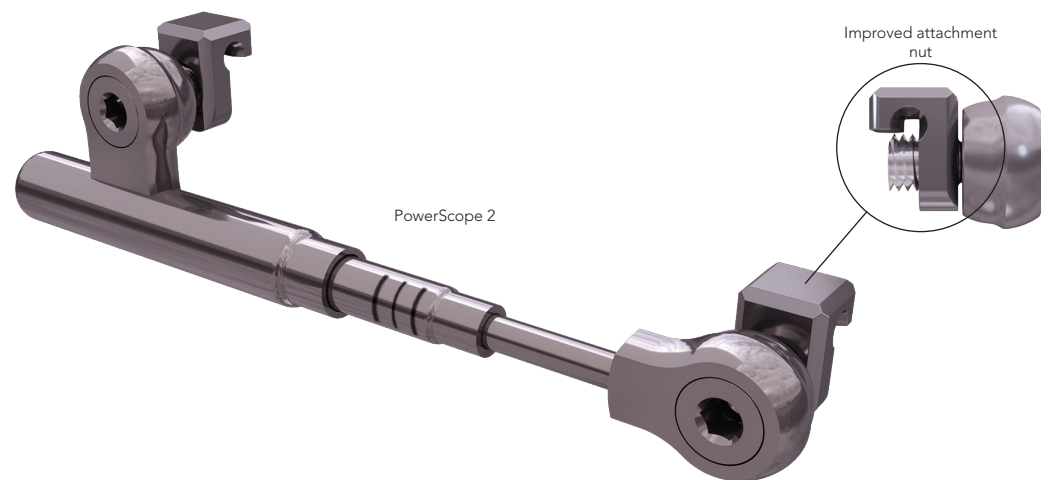

PowerScope 2

Improved attachment nut



Hanks Telescoping Herbst®

- One piece design for easy installation
- Telescoping mechanism will not disengage
- Unique ball and socket design provides unrestricted lateral excursion
- Increased patient acceptance
- Skeletal and dental movement

Hanks Telescoping Herbst

| | Right | Left |
|-------|----------|----------|
| 16 mm | 855-416R | 855-416L |
| 18 mm | 855-418R | 855-418L |
| 21 mm | 855-421R | 855-421L |
| 24 mm | 855-424R | 855-424L |
| 27 mm | 855-427R | 855-427L |

Hanks Telescoping Herbst with Rollo Band

| Rollo Band Kit** 855-720 - 40 Total | | | |
|--|---|-------|------|
| Qty | | Right | Left |
| 16 | 18 mm HTH | 8 | 8 |
| 12 | 21 mm HTH | 6 | 6 |
| 8 | 24 mm HTH | 4 | 4 |
| 4 | 27 mm HTH | 2 | 2 |
| 40 | Rollo Band w/Barrel Nut** | 20 | 20 |
| 40 | Rollo Band - 16.5 mm Preformed Cantilever** | 20 | 20 |
| 80 | 1 mm crimpable shims | | |
| 80 | 2 mm crimpable shims | | |
| 2 | Hex Wrench | | |

**STANDARD WITH KIT
Barrel Nut on maxillary and 16.5 mm cantilever on mandibular band.
Rollo Band sizes distributed by usage.



Rollo Band + Universal Nut + HTH

Barrel Nut

Rollo Band with cantilever bar and cantilever nut

Hanks Telescoping Herbst Components

| Sold in units of 1/pkg | Size | Right | Left |
|--------------------------|----------|----------|----------|
| Preformed Cantilever Bar | 9 mm | 855-739R | 855-739L |
| | 12 mm | 855-744R | 855-744L |
| | 14 mm | 855-745R | 855-745L |
| | 16.5 mm | 855-741R | 855-741L |
| | 18.5 mm | 855-742R | 855-742L |
| | 20.5 mm | 855-743R | 855-743L |
| Universal Cantilever Bar | 4 inches | 855-748 | |

Sold in units of 10/pkg

| | | |
|----------------------|-----------|-----------|
| Universal Nut w/Hook | 855-727HR | 855-727HL |
| Universal Nut | 855-727 | |
| Barrel Nut | 855-726 | |
| Cantilever Nut | 855-732 | |

Sold in units of 10/pkg

| | | |
|-----------------|------|---------|
| Crimpable Shims | 3 mm | 855-738 |
| | 2 mm | 855-728 |
| | 1 mm | 855-733 |

Sold in units of 2/pkg

| | |
|------------|---------|
| Hex Wrench | 855-373 |
|------------|---------|

**AVAILABLE UPON REQUEST WITH KIT
Universal Nut on maxillary and 9 mm, 12 mm, 14 mm, 16.5 mm, 18.5 mm cantilever.

Self-Ligating Brackets
Metal Brackets
Cosmetic Brackets
DB Tubes
Bands
Lingual Attachments
Weldable Tubes
Adhesives
Wire
Elastomerics
Mini Implants
Fixed & Functional
Stops & Hooks
Extraoral
Instruments
Supplies & Marketing
Custom Rx



MiniScope Telescoping Herbst

| | Right | Left |
|-------|----------|----------|
| 18 mm | 855-918R | 855-918L |
| 21 mm | 855-921R | 855-921L |
| 24 mm | 855-924R | 855-924L |
| 27 mm | 855-927R | 855-927L |
| 31 mm | 855-931R | 855-931L |

MiniScope with Rollo Band

| Rollo Band Kit** 855-920 - 40 Total | | | |
|--|---|-------|------|
| Qty | | Right | Left |
| 16 | 18 mm MiniScope | 8 | 8 |
| 12 | 21 mm MiniScope | 6 | 6 |
| 8 | 24 mm MiniScope | 4 | 4 |
| 4 | 27 mm MiniScope | 2 | 2 |
| 40 | Rollo Band w/Barrel Nut** | 20 | 20 |
| 40 | Rollo Band - 16.5 mm Preformed Cantilever** | 20 | 20 |
| 80 | AppleCore Screws | | |
| 80 | 1 mm crimpable shims | | |
| 80 | 2 mm crimpable shims | | |
| 2 | Hex Wrench | | |

**STANDARD WITH KIT

Barrel Nut on maxillary and 16.5 mm cantilever on mandibular band.

Rollo Band sizes distributed by usage.

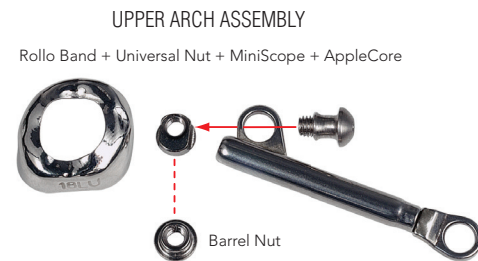

MiniScope™ Telescoping Herbst®

- Can be integrated into any existing system of crowns and attachments
- Telescoping mechanism will not disengage
- Unrestricted lateral excursion when used with the AppleCore Screw

MiniScope Components

| Sold in units of 1/pkg | Size | Right | Left |
|-----------------------------------|----------|----------|----------|
| Preformed Cantilever Bar, Offset | 9 mm | 855-739R | 855-739L |
| | 12 mm | 855-744R | 855-744L |
| | 14 mm | 855-745R | 855-745L |
| | 16.5 mm | 855-741R | 855-741L |
| | 18.5 mm | 855-742R | 855-742L |
| | 20.5 mm | 855-743R | 855-743L |
| Universal Cantilever Bar | | | |
| With cantilever nut perpendicular | 4 inches | 855-740 | |
| With cantilever nut horizontal | 4 inches | 855-748 | |

| Sold in units of 10/pkg | Right | Left |
|-------------------------|-----------|-----------|
| Universal Nut w/Hook | 855-727HR | 855-727HL |
| Universal Nut | 855-727 | |
| Barrel Nut | 855-726 | |
| Cantilever Nut | 855-732 | |
| AppleCore Screw | 855-735 | |

| Sold in units of 10/pkg | Size | |
|-------------------------|------|---------|
| Crimpable Shims | 1 mm | 855-733 |
| | 2 mm | 855-728 |
| | 3 mm | 855-738 |

| Sold in units of 2/pkg | |
|------------------------|---------|
| Hex Wrench | 855-373 |

**AVAILABLE UPON REQUEST WITH KIT
Universal Nut on maxillary and 9 mm, 12 mm, 14 mm, 16.5 mm, 18.5 mm cantilever.



Herbst Appliance

| 1 Patient Kit 855-360 | | | |
|--------------------------|--------------------|-------|------|
| Qty | | Right | Left |
| 2 | Straight Rods | | |
| 2 | Sleeves | 1 | 1 |
| 4 | Hex Head Screws | | |
| 1 | Hex Head Wrench | | |
| 2 | Standard Nuts | | |
| 2 | Standard Flat Nuts | | |

Reorder Components

| Sold in units of 10/pkg | |
|-------------------------|---------|
| Straight Rod | 855-361 |
| Offset Rod | 855-362 |
| Hex Head Screws | 855-365 |
| Standard Nuts | 855-366 |
| Standard Flat Nuts | 855-367 |

| Sold in units of 10/pkg | Right | Left |
|-------------------------|---------|---------|
| Sleeve | 855-363 | 855-364 |

| Sold in units of 10/pkg | Size | |
|-------------------------|------|---------|
| Advancers | 1 mm | 855-368 |
| | 2 mm | 855-369 |
| | 3 mm | 855-370 |
| | 4 mm | 355-371 |
| | 5 mm | 855-372 |

| Sold in units of 2/pkg | |
|------------------------|---------|
| Hex Head Wrenches | 855-373 |

| Sold in units of 1/pkg | Size | Right | Left |
|--|----------|------------|------|
| Universal Cantilever Bar | | | |
| With standard flat nut | 4 inches | 852-027452 | |
| With standard flat nut and .022 Inconel Tube | 4 inches | 852-027453 | |

Herbst® Appliance

- Hex head screws for ease of use and maximum patient comfort
- Offset rods provide a lower profile
- Advancers to reactivate mandibular advancement are available in five lengths from 1 mm to 5 mm
- Standard nut for safe and secure solders every time

Preformed Cantilever Bar, Offset with standard nut/Inconel

| Size | Right | Left |
|---------|------------|------------|
| 9 mm | 855-039RCP | 855-039LCP |
| 16.5 mm | 855-041RCP | 855-041LCP |
| 18.5 mm | 855-042RCP | 855-042LCP |
| 20.5 mm | 855-043RCP | 855-043LCP |
| 12 mm | 855-044RCP | 855-044LCP |
| 14 mm | 855-045RCP | 855-045LCP |

Preformed Cantilever Bar, Offset with standard nut

| Size | Right | Left |
|---------|------------|------------|
| 9 mm | 855-839RCP | 855-839LCP |
| 16.5 mm | 855-841RCP | 855-841LCP |
| 18.5 mm | 855-842RCP | 855-842LCP |
| 20.5 mm | 855-843RCP | 855-843LCP |
| 12 mm | 855-844RCP | 855-844LCP |
| 14 mm | 855-845RCP | 855-845LCP |

* Herbst® is a registered trademark of Dentaaurum, Inc.

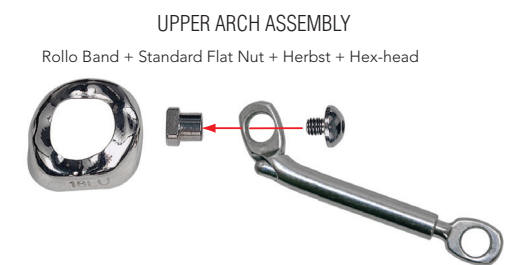

LOWER ARCH ASSEMBLY

Rollo Band with cantilever bar and Standard Flat Nut + inconel tube



*Hex Head Screw specific to standard nut and standard flat nut application



Rollo Bands

- 141-000 Upper right
- 142-000 Upper left
- 153-000 Lower right
- 154-000 Lower left

| SIZE | KIT SIZE | |
|-----------------|-----------|-----------|
| | 40 | 80 |
| 6 | 1 | 2 |
| 9 | 1 | 2 |
| 12 | 1 | 2 |
| 15 | 2 | 4 |
| 18 | 2 | 4 |
| 21 | 2 | 4 |
| 24 | 3 | 6 |
| 27 | 3 | 6 |
| 30 | 3 | 6 |
| 33 | 2 | 4 |
| PER SIDE | 20 | 40 |

Rollo Band Configurations for HTH and MiniScope Assemblies

Upper



Universal Nut

| Right | Left |
|---------|---------|
| 141-201 | 142-201 |



Universal Nut and Hook

| Right | Left |
|----------|----------|
| 141-201H | 142-201H |



Barrel Nut

| Right | Left |
|---------|---------|
| 141-200 | 142-200 |



Barrel Nut and 4.5 mm .018 Tube

| Right | Left |
|----------|----------|
| 141-218T | 142-218T |



Barrel Nut and 4.5 mm .022 Tube

| Right | Left |
|----------|----------|
| 141-222T | 142-222T |

Lower

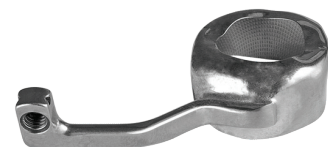

Cantilever Bar and Cantilever Nut

| | Right | Left |
|---------|---------|---------|
| 9 mm | 153-299 | 154-299 |
| 12 mm | 153-303 | 154-303 |
| 14 mm | 153-304 | 154-304 |
| 16.5 mm | 153-300 | 154-300 |
| 18.5 mm | 153-301 | 154-301 |
| 20.5 mm | 153-302 | 154-302 |



Mini Skirt Crowns

These stainless steel crowns are specially designed to be used with Herbst® appliances and other orthopedic/orthodontic appliances that require the stability of a crown for anchorage. Shorter occlusal-gingival dimension than a traditional crown. Enhanced interproximal festooning reduces amount of material that must be trimmed.

Mini Skirt Crowns

| Size | Upper Right | Upper Left | Lower Right | Lower Left |
|------|-------------|------------|-------------|------------|
| 4 | 171-004 | 172-004 | 173-004 | 174-004 |
| 5 | 171-005 | 172-005 | 173-005 | 174-005 |
| 6 | 171-006 | 172-006 | 173-006 | 174-006 |
| 7 | 171-007 | 172-007 | 173-007 | 174-007 |
| 8 | 171-008 | 172-008 | 173-008 | 174-008 |

Mini Skirt Crowns with Barrel Nuts

| Size | Upper Right | Upper Left |
|------|-------------|------------|
| 4 | 171-004N | 172-004N |
| 5 | 171-005N | 172-005N |
| 6 | 171-006N | 172-006N |
| 7 | 171-007N | 172-007N |
| 8 | 171-008N | 172-008N |

| Crown Kit (56 Crowns) 170-000 | | Crown with Barrel Nuts Kit (28 Crowns) 171-000N | |
|----------------------------------|-----------------------------|--|-------------------|
| 3 ea | Size 4 Uppers and Lower R/L | 3 ea | Size 4 Uppers R/L |
| 4 ea | Size 5 Uppers and Lower R/L | 4 ea | Size 5 Uppers R/L |
| 4 ea | Size 6 Uppers and Lower R/L | 4 ea | Size 6 Uppers R/L |
| 2 ea | Size 7 Uppers and Lower R/L | 2 ea | Size 7 Uppers R/L |
| 1 ea | Size 8 Uppers and Lower R/L | 1 ea | Size 8 Uppers R/L |

Mini Skirt Crown Configurations



Universal Nut and Hook

| Upper Right | Upper Left |
|-------------|------------|
| 171-201H | 172-201H |



Barrel Nut and 4.5 mm .018 Tube

| Upper Right | Upper Left |
|-------------|------------|
| 171-218T | 172-218T |



Barrel Nut and 4.5 mm .022 Tube

| Upper Right | Upper Left |
|-------------|------------|
| 171-222T | 172-222T |



Jasper Jumper with sectional wire



Gentle Jumper with sectional wire

Jasper Jumper and Gentle Jumper

As an adjunct to fixed appliance therapy, the Jasper Jumper and the Gentle Jumper present an opportunity to minimize extractions and to reduce or eliminate headgear. When activated 4 mm, the Jasper Jumper will exert 360 grams of force. By comparison, at the same amount of deflection, the Gentle Jumper exerts just 75 grams of force, which is better suited to mixed dentition cases.

| Size | Jasper Jumper* | | Gentle Jumper* | |
|-----------|----------------|----------|----------------|----------|
| | Right | Left | Right | Left |
| 1 - 26 mm | 852-901R | 852-901L | | |
| 2 - 28 mm | 852-902R | 852-902L | | |
| 3 - 30 mm | 852-903R | 852-903L | 852-673R | 852-673L |
| 4 - 32 mm | 852-904R | 852-904L | 852-674R | 852-674L |
| 5 - 34 mm | 852-905R | 852-905L | 852-675R | 852-675L |
| 6 - 36 mm | 852-907R | 852-907L | 852-676R | 852-676L |
| 7 - 38 mm | 852-908R | 852-908L | | |

* Individual Jumpers include 2 ball pins and 2 ball stops

Jumper Components

- 851-610 100 .018 x .025 Solid crimpable arch stop
- 851-611 100 .022 x .028 Solid crimpable arch stop
- 851-612 100 .018 x .025 Split crimpable arch stop
- 851-613 100 .022 x .028 Split crimpable arch stop
- 852-906 10 ea Ball pins and stops
- 005-002 1 Consultation model

| Jasper Jumper Kit - 10 pairs 852-900 | | Gentle Jumper Kit - 10 pairs 852-670 | |
|---|----------------------------|---|--------------|
| 1 pair ea | 26 mm, 28 mm, 36 mm, 38 mm | 2 pair ea | 30 mm, 36 mm |
| 2 pair ea | 30 mm, 32 mm, 34 mm | 3 pair ea | 32 mm, 34 mm |
| 27 | ball pins | 27 | ball pins |
| 36 | ball stops | 36 | ball stops |

Sectional wire for Jasper and Gentle Jumper

852-912

.017 x .025 - Package of 30

A sectional wire has been specially designed for Jasper Jumper and Gentle Jumper use. The uniqueness of this wire lies in the anterior loop design and its attachment to the main arch wire. This loop design allows for attachment to the main arch from lingual to buccal as opposed to the conventional wrap around from buccal to lingual. The advantages are lower profile and minimal patient irritation in addition to trouble free action and the virtual impossibility of displacement from the main arch.



MSDS information and technical usage

www.americanortho.com



Jones Jig

The Jones Jig is a simple, but effective appliance for distalizing upper molars. It may be used for bilateral or unilateral corrections. The mainframe is inserted into the buccal tube and ligated. The superelastic coil spring is slid onto the mainframe wire and secured by the sliding eyelet tube. Force is obtained by compressing the spring and ligating the eyelet to the bicuspid bracket. Anchorage support is provided with a Nance appliance.

When ordering, please specify position of headgear tube and slot size.

Jones Jig

| .018 Kit Headgear Occlusal 855-400 | .022 Kit Headgear Occlusal 855-401 |
|---|---|
| .018 Kit Headgear Gingival 855-402 | .022 Kit Headgear Gingival 855-403 |
| 20 Mainframes 20 Springs 22 Sliding eyelets | 20 Mainframes 20 Springs 22 Sliding eyelets |

Jones Jig Reorder Components

- 855-404 1 Mainframe .018 headgear occlusal
- 855-405 1 Mainframe .022 headgear occlusal
- 855-412 1 Mainframe .018 headgear gingival
- 855-413 1 Mainframe .022 headgear gingival
- 855-410 1 Spring
- 855-411 1 Sliding eyelet tube
- 005-003 1 Consultation model



Rapid Molar Intruder

This device provides a simple, effective solution to the management of vertical dysplasias in both growing children and adults. Easy to place and manage clinically, the RMI does not require patient cooperation to be functional. The RMI is aesthetic and unobtrusive, does not compromise oral hygiene, has excellent patient acceptance, and has proven results.

| RMI Kit 852-200 | |
|--------------------|--------------------------|
| 3 pair | Mixed dentition - Size M |
| 2 pair | Adult dentition - Size A |
| 20 | Ball pin connectors |

Rapid Molar Intruder Reorder Components

- 852-201 1 pair Mixed dentition Size M, 4 ball pin connectors
- 852-202 1 pair Adult dentition Size A, 4 ball pin connectors
- 852-203 10 Ball pin connectors



MSDS information and technical usage

Self-Ligating Brackets
Metal Brackets
Cosmetic Brackets
DB Tubes
Bands
Lingual Attachments
Weldable Tubes
Adhesives
Wire
Elastomers
Mini Implants
Fixed & Functional
Stops & Hooks
Extraoral
Instruments
Supplies & Marketing
Custom Rx



Distal Jet *the distal JET*

A superior distalizer combining pure translation with excellent anchorage control and positive, simple molar retention in one appliance.

Typical clinical situations for the Distal Jet are:
 Class II maxillary protrusion
 Class II molar relations resulting from missing or blocked out teeth
 Class II subdivision (unilateral) cases

Distal Jet can be anchored to 2nd bicuspid in cases requiring maximum anterior anchorage control.

| Distal Jet Kit - 5 patients 855-500 | |
|--|-------------------------|
| 10 | Bondable connectors |
| 5 | Transpalatal connectors |
| 10 | Bayonet directors |
| 10 | Standard bayonets |
| 10 | NiTi springs - 240 gm |
| 10 | NiTi springs - 180 gm |
| 10 | Lingual sheaths |
| 10 | Activation locks |
| 10 | Distal stops |
| 1 | Hex wrench |

005-004 Distal Jet Consultation model

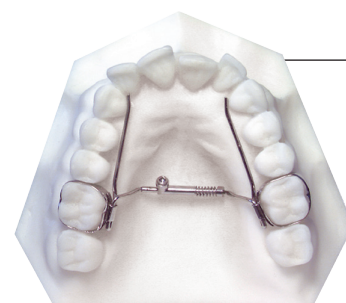

Spring Jet 1 - Dental expansion

Spring Jet *the spring JET*

Typical clinical situations for the Spring Jet are:
 Cross-bite relations
 Collapsed arches
 Micrognathia
 Arch development

Spring Jet 1 for Dental Expansion

The replacement for all existing wireform expanders with precise force-counterforce mechanics. Achieve slow arch expansion with controlled, continuous NiTi spring force.

Spring Jet 2 for Orthopedic Expansion

Substitute for all screw or pre-set wire expanders. Unique delivery system for reliable results with minimal tipping requires no patient compliance or activation.

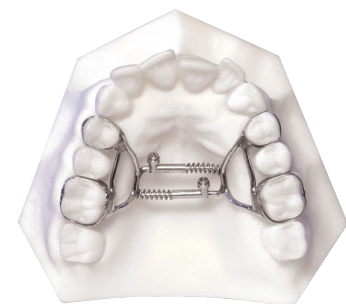

Spring Jet 2 - Orthopedic expansion

| Spring Jet Kit - 5 patients 855-520 | |
|--|-------------------------------------|
| 10 | Bayonet directors |
| 10 | Lingual sheaths |
| 10 | Activation locks |
| 10 | Distal stops |
| 10 | Lengths .036 wire - 4.5"/11.43 cm |
| 10 | Lengths .045 wire - 3.5"/8.89 cm |
| 1 | 15" spool NiTi coil spring - 400 gm |
| 1 | Hex wrench |

005-005 Spring Jet 1 Consultation model
 005-006 Spring Jet 2 Consultation model



Mesial Jet *the mesial JET*

Controlled bodily movement of terminal teeth in either arch is a snap with this design - especially anterior space closure.

Typical clinical situations for the Mesial Jet are:
 Second bicuspid extraction cases
 Span reduction for prosthetics
 Closing spaces resulting from congenitally missing teeth

| Mesial Jet Kit - 5 patients 855-522 | |
|--|-----------------------------------|
| 10 | Bayonet directors |
| 10 | Lingual sheaths |
| 10 | NiTi springs - 240 gm |
| 10 | NiTi springs - 180 gm |
| 10 | Activation locks |
| 10 | Lengths .036 wire - 4.5"/11.43 cm |
| 1 | Hex wrench |

005-007 Dual Consultation model - Mesial Jet/Uprighter Jet



Uprighter Jet *the uprighter JET*

Uprighting tipped or partially impacted teeth is accomplished in a straightforward manner without affecting the rest of the dentition.

Typical clinical situations for the Uprighter Jet are:
 Pre-prosthetic abutment uprighting
 Partial impactions
 Tipping as a result of premature loss of deciduous teeth

| Uprighter Jet Kit - 5 patients 855-513 | |
|---|----------------------------|
| 10 | Uprighter bayonets - right |
| 10 | Uprighter bayonets - left |
| 10 | Lingual button attachments |
| 10 | Bayonet directors |
| 10 | NiTi springs - 240 gm |
| 10 | NiTi springs - 180 gm |
| 10 | Activation locks |
| 10 | Distal stops |
| 1 | Hex wrench |

005-007 Dual Consultation model - Uprighter Jet/Mesial Jet

Jet Family Reorder Components

| | | | | | |
|---------|----|--------------------------------|---------|-----|---|
| 855-602 | 10 | Bayonet directors | 855-510 | 10 | Distal stops |
| 855-503 | 10 | Bondable connectors | 855-511 | 10 | Uprighter bayonets - right |
| 855-504 | 10 | Standard bayonets | 855-512 | 10 | Uprighter bayonets - left |
| 855-505 | 5 | Transpalatal connectors | 855-616 | 1 | 15" spool NiTi spring - ID .063, 240 gm |
| 855-606 | 10 | NiTi springs - ID .063, 240 gm | 855-617 | 1 | 15" spool NiTi spring - ID .063, 400 gm |
| 855-607 | 10 | NiTi springs - ID .063, 180 gm | 855-518 | 10 | Lengths .036 wire, 4.5"/11.43 cm |
| 855-608 | 10 | Activation locks | 855-519 | 10 | Lengths .045 wire, 3.5"/8.89 cm |
| 855-501 | 10 | Activation lock set screws | 852-170 | 100 | Lingual buttons |
| 855-509 | 2 | Hex wrenches | 852-141 | 10 | Lingual sheaths |
| 855-515 | 1 | Hex head driver | 851-744 | 100 | Crimpable stops - 2 mm |



Goshgarian Palatal Arch

Provides positive control of upper molars
Simplifies and expedites the rotation and torquing of upper molars
.036 wire
5 per package

| | |
|---------|-------|
| 852-521 | 34 mm |
| 852-522 | 37 mm |
| 852-523 | 41 mm |
| 852-525 | 45 mm |
| 852-526 | 47 mm |
| 852-527 | 49 mm |
| 852-528 | 52 mm |

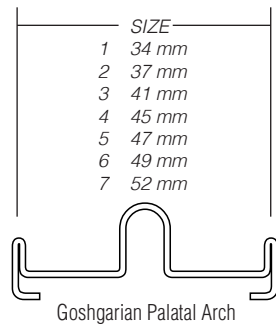

Goshgarian Palatal Arch

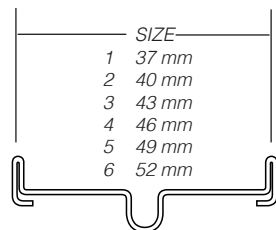

Reverse Loop Palatal Arch

Reverse Loop Palatal Arch

Mesial or facially oriented adjustment loop is less likely to cause a gag reflex
Increased tongue action on the loop will improve and speed the desired tooth movement
Long leg for easier, more secure ligation
.036 wire
5 per package

| | |
|----------|-------|
| 852-541L | 37 mm |
| 852-542L | 40 mm |
| 852-543L | 43 mm |
| 852-544L | 46 mm |
| 852-545L | 49 mm |
| 852-546L | 52 mm |

WARNING: The palatal arch should be securely ligated into the lingual sheath with steel or elastic ligatures. Improper use may result in injury or death by aspiration or ingestion.

| Goshgarian Palatal Arch Kit 852-530 | | Reverse Loop Palatal Arch Kit 852-540L | |
|-------------------------------------|------------|--|------------|
| 4 | 34 mm arch | 5 | 37 mm arch |
| 4 | 37 mm arch | 5 | 40 mm arch |
| 4 | 41 mm arch | 5 | 43 mm arch |
| 4 | 45 mm arch | 5 | 46 mm arch |
| 4 | 47 mm arch | 5 | 49 mm arch |
| 4 | 49 mm arch | 5 | 52 mm arch |

Quad Helix

Preformed .036 appliance designed to gently expand and develop the upper arch
Can assist in correcting tooth rotations, crown torque, and crown tip
Available in 3 sizes and with curved or straight sheaths
3 per package

| | Straight | Curved |
|--------|----------|---------|
| Small | 852-551 | 852-554 |
| Medium | 852-552 | 852-555 |
| Large | 852-553 | 852-556 |

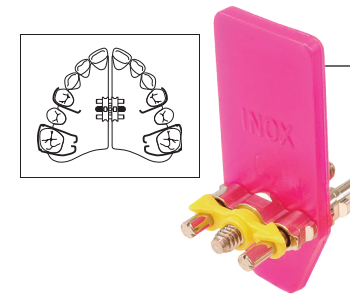
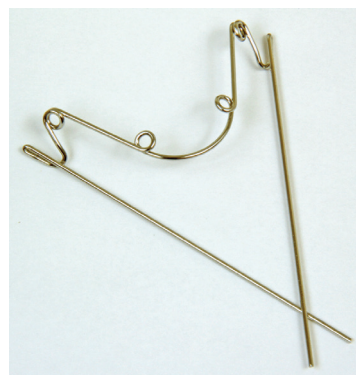

Standard Expansion Screw For transverse expansion in upper acrylic appliances

| Housing length | M-D length | Height | Maximum expansion | One complete turn | Pieces per pack | Part # |
|----------------|------------|--------|-------------------|-------------------|-----------------|---------|
| 14 mm | 9.85 mm | 3.5 mm | 9 mm | .8 mm | 5 | 855-244 |

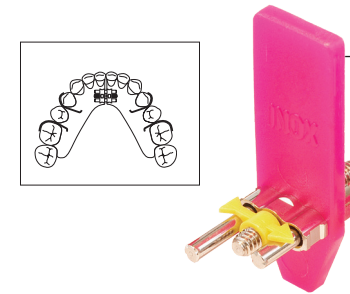

Medium Expansion Screw For use in both upper and lower acrylic appliances

| Housing length | M-D length | Height | Maximum expansion | One complete turn | Pieces per pack | Part # |
|----------------|------------|--------|-------------------|-------------------|-----------------|---------|
| 11 mm | 7.25 mm | 3 mm | 7 mm | .8 mm | 5 | 855-245 |
| 14 mm | 7.25 mm | 3 mm | 9 mm | .8 mm | 5 | 855-247 |

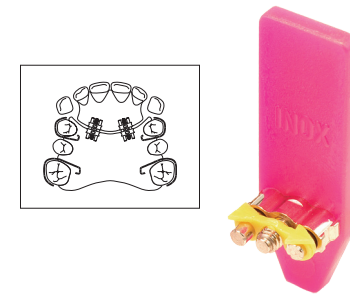

Micro Expansion Screw For narrow palates and lower arches

| Housing length | M-D length | Height | Maximum expansion | One complete turn | Pieces per pack | Part # |
|----------------|------------|--------|-------------------|-------------------|-----------------|---------|
| 10 mm | 6.4 mm | 3 mm | *6 mm | .7 mm | 5 | 855-246 |

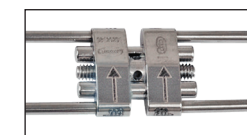
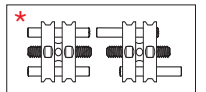

Mini Rapid Hygienic Expansion Screw Greater expansion with no slippage

| 4 Arm | Housing length | M-D length | Height | Maximum expansion | One complete turn | Pieces per pack | Part # |
|-------|----------------|------------|--------|-------------------|-------------------|-----------------|---------|
| | 12 mm | 11 mm | 3.5 mm | 8 mm | .8 mm | 1 | 855-241 |
| | 14 mm | 11 mm | 3.5 mm | 9 mm | .8 mm | 1 | 855-242 |
| | 15 mm | 11 mm | 3.5 mm | 11 mm | .8 mm | 1 | 855-243 |
| | 18 mm | 11 mm | 3.5 mm | 13 mm | .8 mm | 1 | 855-240 |

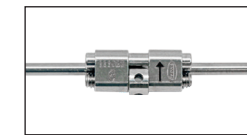

| 2 Arm | Housing length | M-D length | Height | Maximum expansion | One complete turn | Pieces per pack | Part # |
|-------|----------------|------------|--------|-------------------|-------------------|-----------------|----------|
| | 13 mm | 11 mm | 5 mm | 8 mm | .8 mm | 1 | 855-2410 |
| | 16 mm | 11 mm | 5 mm | 11 mm | .8 mm | 1 | 855-2430 |

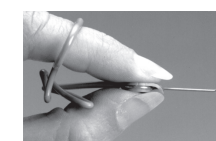
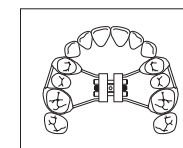

Expansion Screw Key

855-249 25 per package



Swivel Smart Key™

855-2490 10 per package

Swivel Smart Key is a trademark of Leone American Tooth Industries



Quick Fix

Ideal for treating most Class III, pseudo Class III, and anterior crossbite cases. Can be used in any case where it is necessary to create space for erupting canines and premolars, or where positive overjet is required. Can be used effectively with TAD's.

| Quick Fix Kit - 10 patient 852-781 | |
|---------------------------------------|-----------------------------|
| 10 | Right Side Swipe |
| 10 | Left Side Swipe |
| 20 | Universal arch lock |
| 20 | Open coil stainless springs |
| 20 | Open coil NiTi springs |
| 1 | Hex wrench |

Reorder components

| | | |
|-----------|----|---------------------------------------|
| 851-638CR | 10 | Right Side Swipe |
| 851-638CL | 10 | Left Side Swipe |
| 851-652 | 10 | Universal arch lock |
| 855-151C | 1 | Open coil stainless steel spring, 36" |
| 855-172 | 20 | Open coil NiTi spring, 20 mm |
| 851-655 | 5 | Hex wrench |

IMPORTANT:
Lip bumpers must be securely ligated to the bumper tube.

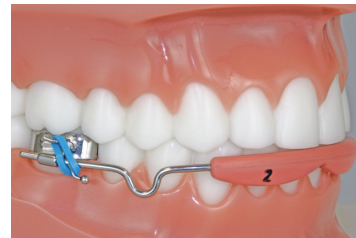

Alexander Lip Bumper

Distal bayonet bends

| | With hook | Without hook |
|---------------|-----------|--------------|
| Size 1, 74 mm | 852-690H | 852-690 |
| Size 2, 85 mm | 852-691H | 852-691 |
| Size 3, 94 mm | 852-692H | 852-692 |



Lip Bumper

Used to distalize, rotate, or upright lower molars

| | With cuspid hook | Without cuspid hook |
|----------------|------------------|---------------------|
| Size 00, 78 mm | 852-699B | 852-699 |
| Size 0, 82 mm | 852-700B | 852-700 |
| Size 1, 85 mm | 852-701B | 852-701 |
| Size 2, 90 mm | 852-702B | 852-702 |
| Size 3, 93 mm | 852-703B | 852-703 |
| Size 4, 96 mm | 852-704B | 852-704 |
| Size 5, 100 mm | 852-705B | 852-705 |

| Lip Bumper Kit 852-706 | Lip Bumper Kit with Hooks 852-706B |
|---------------------------|---------------------------------------|
| 14 Assorted sizes | 14 Assorted sizes |

YC3™ Shield

A pre-formed, one-piece, functional corrector for developing Class III malocclusions with either partial or full anterior crossbites in the deciduous dentition

| | |
|----------|----------------------------|
| 855-710P | Primary dentition patients |
| 855-711M | Mixed dentition patients |

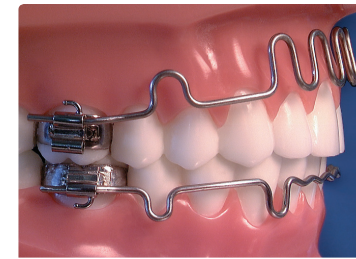

Korn Lip Bumper

Fully adjustable and comfortable. Stimulates lip activity. Controls molar rotations. .040 wire diameter.

| Lip Bumper Kit 852-605 | |
|---------------------------|-------------------|
| 2 | Upper arch large |
| 2 | Upper arch small |
| 2 | Lower arch large |
| 2 | Lower arch medium |
| 2 | Lower arch small |

Reorder components - 1/pkg

| | | |
|---------|---|-------------------------|
| 852-600 | 1 | Upper Arch Large - (0) |
| 852-601 | 1 | Upper Arch Small - (1) |
| 852-602 | 1 | Lower Arch Large - (2) |
| 852-603 | 1 | Lower Arch Medium - (3) |
| 852-604 | 1 | Lower Arch Small - (4) |



Korn Mini-Activator Posturer - M.A.P.

852-609

Preformed thermoplastic resin with multiple treatment applications. Easily moldable chairside. Effective in TMD treatment that requires anterior repositioning. 15 per package.



Bondable Retainer

5 per package

| Upper Central to Central .028 diameter | | Upper Lateral to Lateral .028 diameter | | Lower Cuspid to Cuspid .032 diameter | |
|---|---------|---|---------|---|-----------|
| 4 mm | 855-286 | 14 mm | 855-311 | 22 mm | 855-285 H |
| 6 mm | 855-287 | 16 mm | 855-312 | 24 mm | 855-281 H |
| 7.5 mm | 855-289 | 18 mm | 855-313 | 26 mm | 855-282 H |
| 9 mm | 855-288 | 20 mm | 855-314 | 28 mm | 855-283 H |
| | | | | 30 mm | 855-284 H |

| Central to Central Kit 855-290 | | Lateral to Lateral Kit 855-310 | | Cuspid to Cuspid Kit 855-280 H | |
|-----------------------------------|-----------------------------|-----------------------------------|-------------------------------|-----------------------------------|--------------------------------------|
| 5 ea | 4 mm, 6 mm, 7.5 mm, 9 mm | 5 ea | 14 mm, 16 mm, 18 mm, 20 mm | 4 ea | 22 mm, 24 mm, 26 mm, 28 mm, 30 mm |

H Add "H" to part number for Heat Treated offering



SS Flat Braided Lingual Retainer Wire

| 6" - 10/pkg .010 x .029 | | 60" Spool - 1/pkg .010 x .029 | |
|----------------------------|-------------|----------------------------------|-------------|
| | .010 x .032 | | .010 x .032 |
| 856-SL-1029 | 856-SL-1032 | 856-SP-1029 | 856-SP-1032 |



Bite Blocks

Bonds to lingual surfaces of maxillary teeth creating an instantaneous bite opening effect
10 per package

- 855-200 Short Bite Block
- 855-201 Long Bite Block



Space Maintainer

Anatomical form and offset pads
Minimum order 5 per size
.028 diameter wire

| | Left | Right |
|-------|---------|---------|
| 17 mm | 855-321 | 855-322 |
| 19 mm | 855-323 | 855-324 |
| 21 mm | 855-325 | 855-326 |
| 23 mm | 855-327 | 855-328 |

| Space Maintainer Kit 855-320 | |
|---------------------------------|-----------------------------|
| 2 ea | 17 mm, 19, mm, 21 mm, 23 mm |



Tongue Director

.028 Diameter
10 per package

- 292-184 7.5 mm Bendable Length
- 292-185 7.0 mm Bendable Length

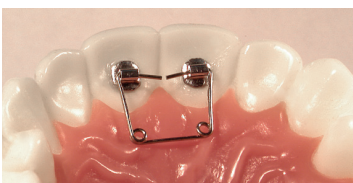

Diastema Closer

Active until contact made, then becomes passive and retains
Universal size

- 855-251 Spring
- 855-252 Direct bond tube on pad

| Diastema Kit 855-250 | |
|-------------------------|-----------------------------|
| 10 | Springs |
| 20 | Tubes |
| 10 | Sectional wire, .017 x .017 |